

Gummigripdon Serie GRU

PICK-UP HEAD

TETE DE PREHENSION

GREIFERKOPF

TULIPA

cod. 001.0035 ø 55

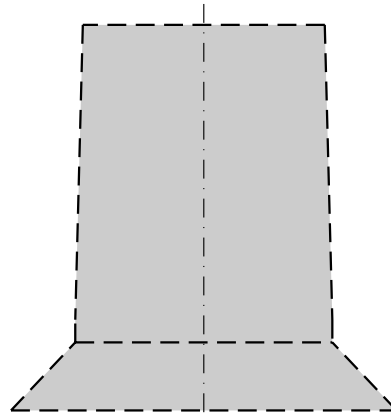
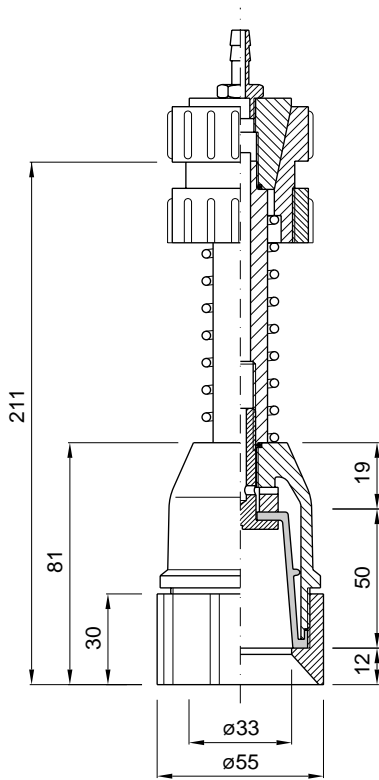

PROFILO INTERNO SCALA 1:1
INTERNAL SECTION SCALE 1:1
PROFIL INTERNE ECHELLE 1:1
INNENPROFIL MASSTAB 1:1
PERFIL INTERIOR ESCALA 1:1

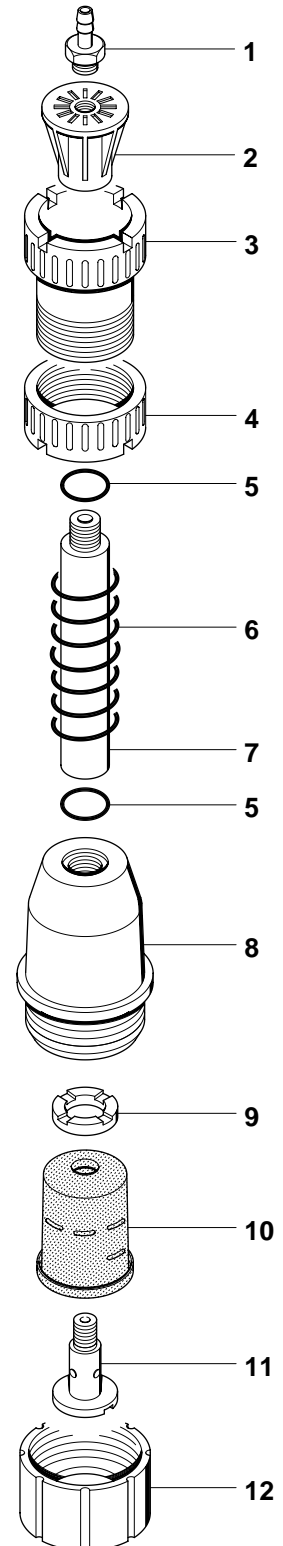

	COD.	MATERIALE	MATERIAL	MATERIEL	WERKSTOFF	MATERIAL
1	024.0001	OTTONE	BRASS	LAITON	MESSING	LATON
2	025.0001	PA 66 + FV	PA 66 + FV	PA 66 + FV	PA 66 + FV	PA 66 + FV
3	026.0001	PA 66 + FV	PA 66 + FV	PA 66 + FV	PA 66 + FV	PA 66 + FV
4	026.0011	PA 66 + FV	PA 66 + FV	PA 66 + FV	PA 66 + FV	PA 66 + FV
5	OR 115	GOMMA	RUBBER	CAOUTCHOUC	GUMMI	GOMA
6	029.0001	AISI	STAINLESS STEEL	ACIER INOXYDABLE	ROSTFREIER STAHL	ACERO INOXIDABLE
7	028.0005	ALLUMINIO	ALUMINIUM	ALUMINIUM	ALUMINIUM	ALUMINIO
8	027.0003	PA 66 + FV	PA 66 + FV	PA 66 + FV	PA 66 + FV	PA 66 + FV
9	032.0208	PA 66 + FV	PA 66 + FV	PA 66 + FV	PA 66 + FV	PA 66 + FV
10	040.0002	GOMMA	RUBBER	CAOUTCHOUC	GUMMI	GOMA
11	032.0009	OTTONE	BRASS	LAITON	MESSING	LATON
12	026.0022	PA 66 + FV	PA 66 + FV	PA 66 + FV	PA 66 + FV	PA 66 + FV

Gummigripdon Serie GRU

PICK-UP HEAD

TETE DE PREHENSION

GREIFERKOPF

TULIPA

cod. 001.0006 ø 55

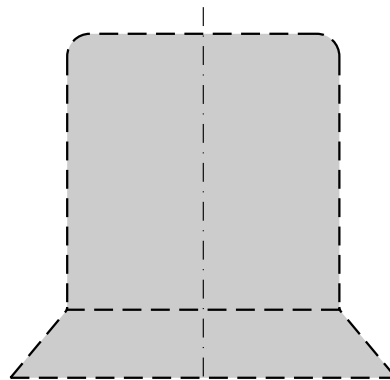
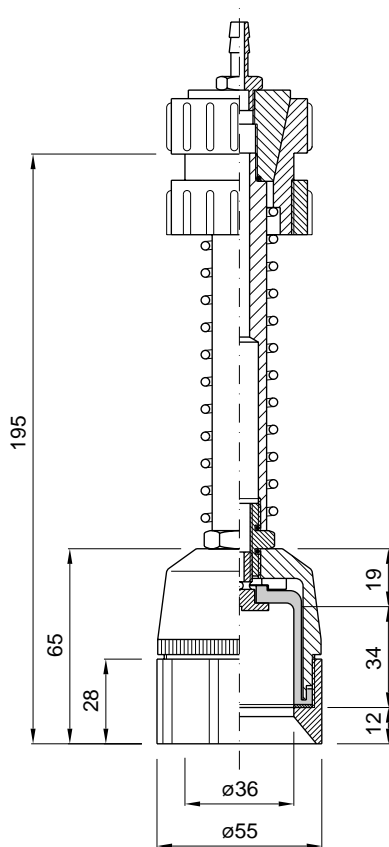

PROFILO INTERNO SCALA 1:1
INTERNAL SECTION SCALE 1:1
PROFIL INTERNE ECHELLE 1:1
INNENPROFIL MASSTAB 1:1
PERFIL INTERIOR ESCALA 1:1

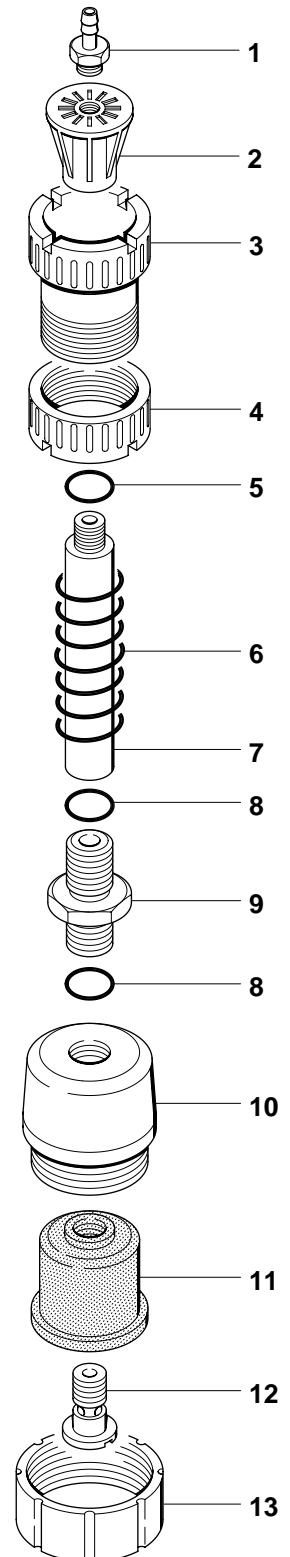

	COD.	MATERIALE	MATERIAL	MATERIEL	WERKSTOFF	MATERIAL
1	024.0001	OTTONE	BRASS	LAITON	MESSING	LATON
2	025.0001	PA 66 + FV	PA 66 + FV	PA 66 + FV	PA 66 + FV	PA 66 + FV
3	026.0001	PA 66 + FV	PA 66 + FV	PA 66 + FV	PA 66 + FV	PA 66 + FV
4	026.0011	PA 66 + FV	PA 66 + FV	PA 66 + FV	PA 66 + FV	PA 66 + FV
5	OR 115	GOMMA	RUBBER	CAOUTCHOUC	GUMMI	GOMA
6	029.0001	AISI	STAINLESS STEEL	ACIER INOXYDABLE	ROSTFREIER STAHL	ACERO INOXIDABLE
7	028.0003	ALLUMINIO	ALUMINIUM	ALUMINIUM	ALUMINIUM	ALUMINIO
8	OR 2050	GOMMA	RUBBER	CAOUTCHOUC	GUMMI	GOMA
9	032.0016	OTTONE	BRASS	LAITON	MESSING	LATON
10	027.0012	PA 66 + FV	PA 66 + FV	PA 66 + FV	PA 66 + FV	PA 66 + FV
11	040.0056	GOMMA / PU	RUBBER / PU	CAOUTCHOUC PU	GUMMI / PU	GOMA / PU
12	032.0001	OTTONE	BRASS	LAITON	MESSING	LATON
13	026.0021	PA 66 + FV	PA 66 + FV	PA 66 + FV	PA 66 + FV	PA 66 + FV

Gummigripdon Serie GRU

PICK-UP HEAD

TETE DE PREHENSION

GREIFERKOPF

TULIPA

cod. 001.0023 ø 80

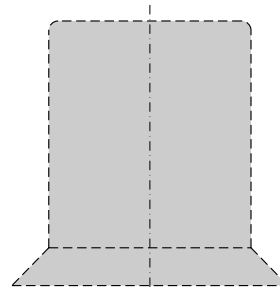
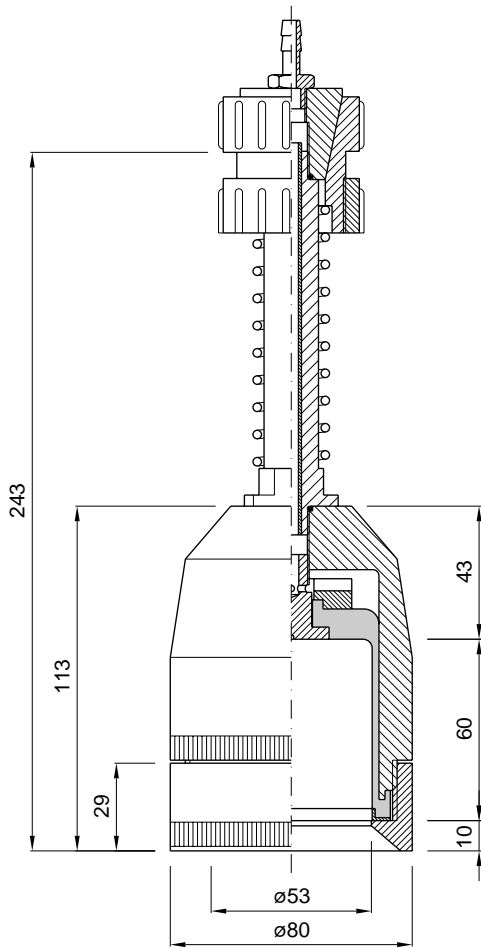

PROFILO INTERNO SCALA 1:2
INTERNAL SECTION SCALE 1:2
PROFIL INTERNE ECHELLE 1:2
INNENPROFIL MASSTAB 1:2
PERFIL INTERIOR ESCALA 1:2

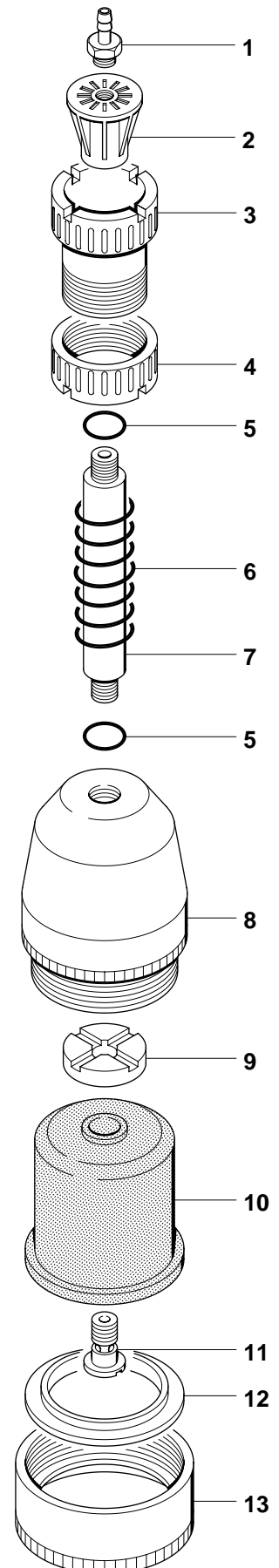

	COD.	MATERIALE	MATERIAL	MATERIEL	WERKSTOFF	MATERIAL
1	024.0001	OTTONE	BRASS	LAITON	MESSING	LATON
2	025.0001	PA 66 + FV	PA 66 + FV	PA 66 + FV	PA 66 + FV	PA 66 + FV
3	026.0001	PA 66 + FV	PA 66 + FV	PA 66 + FV	PA 66 + FV	PA 66 + FV
4	026.0011	PA 66 + FV	PA 66 + FV	PA 66 + FV	PA 66 + FV	PA 66 + FV
5	OR 115	GOMMA	RUBBER	CAOUTCHOUC	GUMMI	GOMA
6	029.0001	AISI	STAINLESS STEEL	ACIER INOXYDABLE	ROSTFREIER STAHL	ACERO INOXIDABLE
7	028.0001	ALLUMINIO	ALUMINIUM	ALUMINIUM	ALUMINIUM	ALUMINIO
8	027.0019	PA 66 + FV	PA 66 + FV	PA 66 + FV	PA 66 + FV	PA 66 + FV
9	032.0203	PA 66 + FV	PA 66 + FV	PA 66 + FV	PA 66 + FV	PA 66 + FV
10	040.0052	GOMMA / PU	RUBBER / PU	CAOUTCHOUC PU	GUMMI / PU	GOMA / PU
11	032.0005	OTTONE	BRASS	LAITON	MESSING	LATON
12	032.0401	AISI	STAINLESS STEEL	ACIER INOXYDABLE	ROSTFREIER STAHL	ACERO INOXIDABLE
13	026.0047	PA 66 + FV	PA 66 + FV	PA 66 + FV	PA 66 + FV	PA 66 + FV

Gummigripdon Serie GRU



PICK-UP HEAD

TETE DE PREHENSION

GREIFERKOPF

TULIPA

cod. 001.0022 ø 80

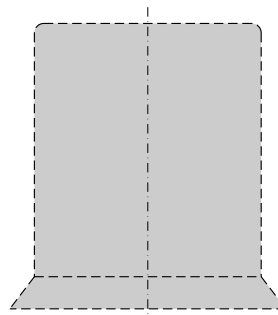
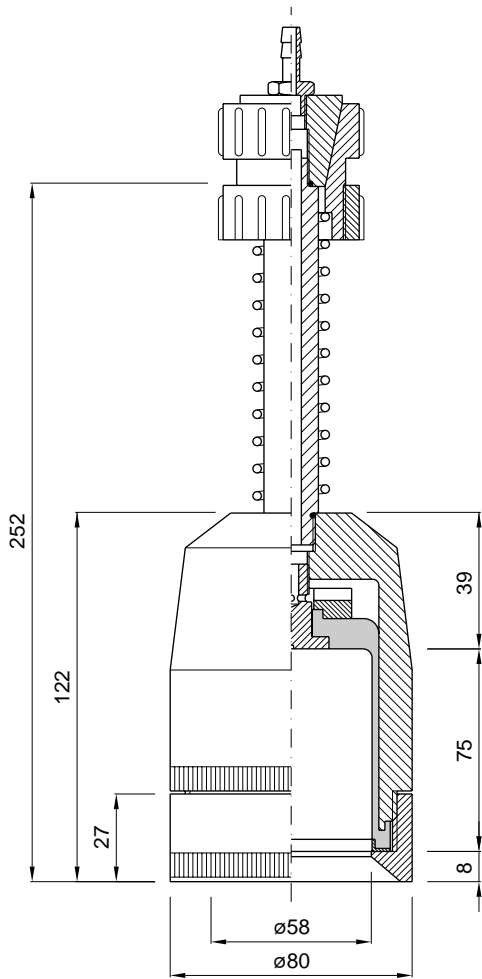

PROFILO INTERNO SCALA 1:2
INTERNAL SECTION SCALE 1:2
PROFIL INTERNE ECHELLE 1:2
INNENPROFIL MASSTAB 1:2
PERFIL INTERIOR ESCALA 1:2

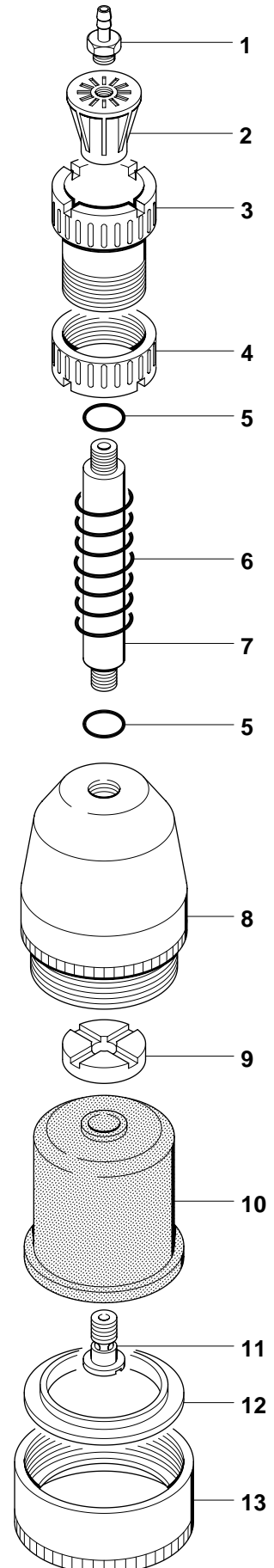

	COD.	MATERIALE	MATERIAL	MATERIEL	WERKSTOFF	MATERIAL
1	024.0001	OTTONE	BRASS	LAITON	MESSING	LATON
2	025.0001	PA 66 + FV	PA 66 + FV	PA 66 + FV	PA 66 + FV	PA 66 + FV
3	026.0001	PA 66 + FV	PA 66 + FV	PA 66 + FV	PA 66 + FV	PA 66 + FV
4	026.0011	PA 66 + FV	PA 66 + FV	PA 66 + FV	PA 66 + FV	PA 66 + FV
5	OR 115	GOMMA	RUBBER	CAOUTCHOUC	GUMMI	GOMA
6	029.0001	AISI	STAINLESS STEEL	ACIER INOXYDABLE	ROSTFREIER STAHL	ACERO INOXIDABLE
7	028.0006	ALLUMINIO	ALUMINIUM	ALUMINIUM	ALUMINIUM	ALUMINIO
8	027.0018	PA 66 + FV	PA 66 + FV	PA 66 + FV	PA 66 + FV	PA 66 + FV
9	032.0203	PA 66 + FV	PA 66 + FV	PA 66 + FV	PA 66 + FV	PA 66 + FV
10	040.0051	GOMMA / PU	RUBBER / PU	CAOUTCHOUC PU	GUMMI / PU	GOMA / PU
11	032.0005	OTTONE	BRASS	LAITON	MESSING	LATON
12	032.0400	AISI	STAINLESS STEEL	ACIER INOXYDABLE	ROSTFREIER STAHL	ACERO INOXIDABLE
13	026.0046	PA 66 + FV	PA 66 + FV	PA 66 + FV	PA 66 + FV	PA 66 + FV

Gummigripdon Serie GRU

PICK-UP HEAD

TETE DE PREHENSION

GREIFERKOPF

TULIPA

cod. 001.0049 ø 87

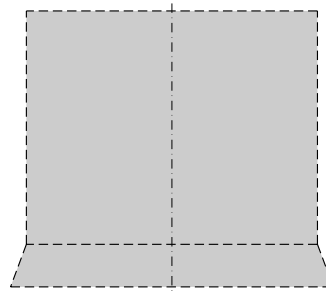
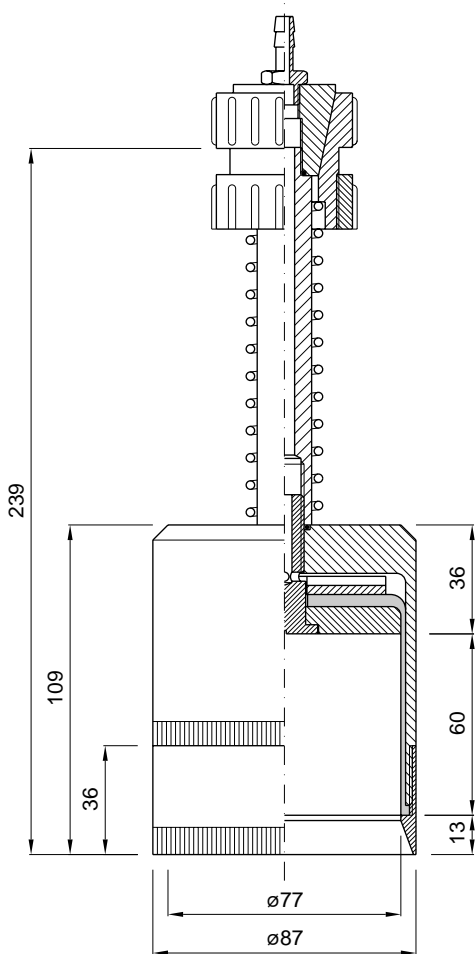

PROFILO INTERNO SCALA 1:2
INTERNAL SECTION SCALE 1:2
PROFIL INTERNE ECHELLE 1:2
INNENPROFIL MASSTAB 1:2
PERFIL INTERIOR ESCALA 1:2

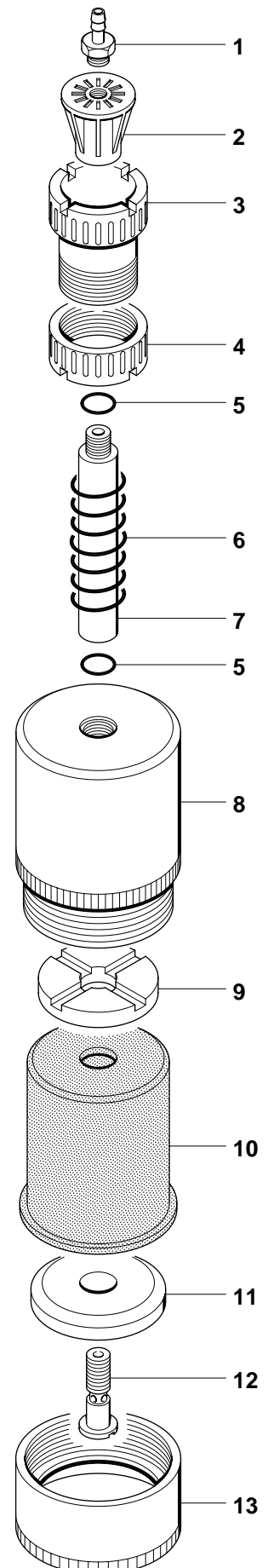

	COD.	MATERIALE	MATERIAL	MATERIEL	WERKSTOFF	MATERIAL
1	024.0001	OTTONE	BRASS	LAITON	MESSING	LATON
2	025.0001	PA 66 + FV	PA 66 + FV	PA 66 + FV	PA 66 + FV	PA 66 + FV
3	026.0001	PA 66 + FV	PA 66 + FV	PA 66 + FV	PA 66 + FV	PA 66 + FV
4	026.0011	PA 66 + FV	PA 66 + FV	PA 66 + FV	PA 66 + FV	PA 66 + FV
5	OR 115	GOMMA	RUBBER	CAOUTCHOUC	GUMMI	GOMA
6	029.0001	AISI	STAINLESS STEEL	ACIER INOXYDABLE	ROSTFREIER STAHL	ACERO INOXIDABLE
7	028.0008	ALLUMINIO	ALUMINIUM	ALUMINIUM	ALUMINIUM	ALUMINIO
8	027.0040	PA 66 + FV	PA 66 + FV	PA 66 + FV	PA 66 + FV	PA 66 + FV
9	032.0211	PA 66 + FV	PA 66 + FV	PA 66 + FV	PA 66 + FV	PA 66 + FV
10	040.0036	GOMMA	RUBBER	CAOUTCHOUC	GUMMI	GOMA
11	030.0022	PA 66 + FV	PA 66 + FV	PA 66 + FV	PA 66 + FV	PA 66 + FV
12	032.0011	OTTONE	BRASS	LAITON	MESSING	LATON
13	026.0082	ALLUMINIO	ALUMINIUM	ALUMINIUM	ALUMINIUM	ALUMINIO

Gummigripdon Serie GRU

PICK-UP HEAD

TETE DE PREHENSION

GREIFERKOPF

TULIPA

cod. 001.0016 \varnothing 42

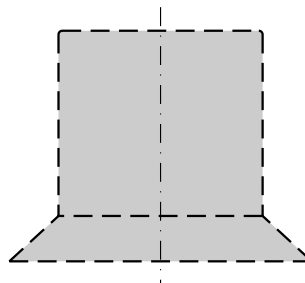
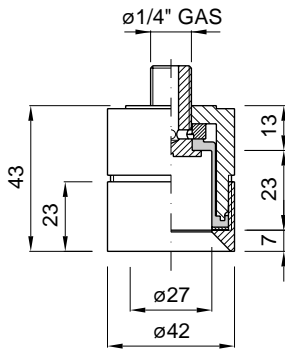

PROFILO INTERNO SCALA 1:1
 INTERNAL SECTION SCALE 1:1
 PROFIL INTERNE ECHELLE 1:1
 INNENPROFIL MASSTAB 1:1
 PERFIL INTERIOR ESCALA 1:1

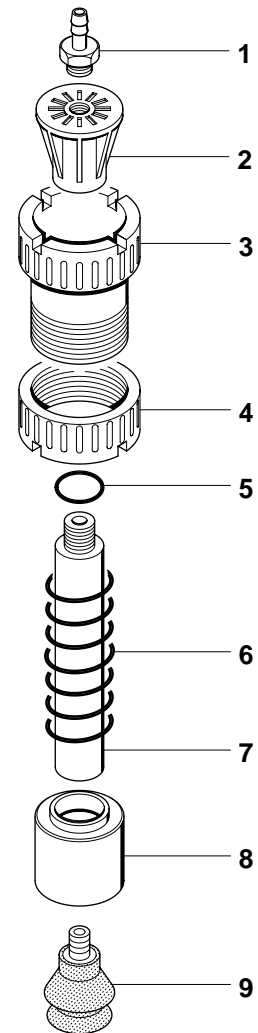

	COD.	MATERIALE	MATERIAL	MATERIEL	WERKSTOFF	MATERIAL
1	027.0016	PA 66 + FV	PA 66 + FV	PA 66 + FV	PA 66 + FV	PA 66 + FV
2	032.0200	PA 66 + FV	PA 66 + FV	PA 66 + FV	PA 66 + FV	PA 66 + FV
3	040.0048	GOMMA	RUBBER	CAOUTCHOUC	GUMMI	GOMA
4	032.0002	OTTONE	BRASS	LAITON	MESSING	LATON
5	026.0042	ALLUMINIO	ALUMINIUM	ALUMINIUM	ALUMINIUM	ALUMINIO

Gummigripdon Serie GRU



PICK-UP HEAD

TETE DE PREHENSION

GREIFERKOPF

TULIPA

cod. 001.0017 ø 32

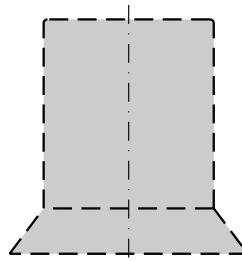
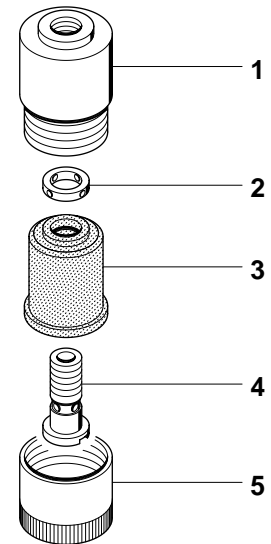
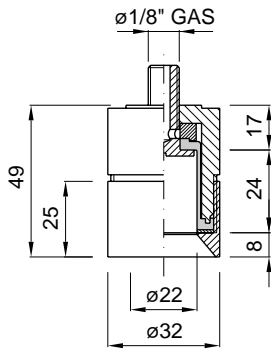

PROFILO INTERNO SCALA 1:1
 INTERNAL SECTION SCALE 1:1
 PROFIL INTERNE ECHELLE 1:1
 INNENPROFIL MASSTAB 1:1
 PERFIL INTERIOR ESCALA 1:1

	COD.	MATERIALE	MATERIAL	MATERIEL	WERKSTOFF	MATERIAL
1	027.0017	PA 66 + FV	PA 66 + FV	PA 66 + FV	PA 66 + FV	PA 66 + FV
2	032.0201	PA 66 + FV	PA 66 + FV	PA 66 + FV	PA 66 + FV	PA 66 + FV
3	040.0047	GOMMA	RUBBER	CAOUTCHOUC	GUMMI	GOMA
4	032.0003	OTTONE	BRASS	LAITON	MESSING	LATON
5	026.0043	ALLUMINIO	ALUMINIUM	ALUMINIUM	ALUMINIUM	ALUMINIO

Gummigripdon Serie GRU

PICK-UP HEAD

TETE DE PREHENSION

GREIFERKOPF

TULIPA

cod. 001.0039 ø 36,5

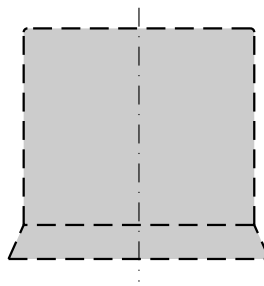
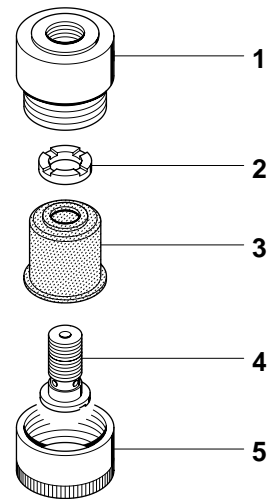
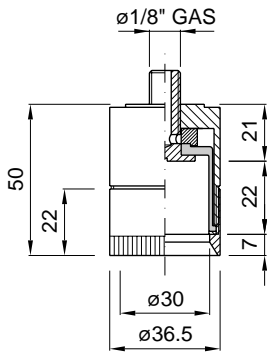

PROFILO INTERNO SCALA 1:1
 INTERNAL SECTION SCALE 1:1
 PROFIL INTERNE ECHELLE 1:1
 INNENPROFIL MASSTAB 1:1
 PERFIL INTERIOR ESCALA 1:1

	COD.	MATERIALE	MATERIAL	MATERIEL	WERKSTOFF	MATERIAL
1	027.0032	ALLUMINIO	ALUMINIUM	ALUMINIUM	ALUMINIUM	ALUMINIO
2	032.0201	PA 66 + FV	PA 66 + FV	PA 66 + FV	PA 66 + FV	PA 66 + FV
3	040.0075	GOMMA	RUBBER	CAOUTCHOUC	GUMMI	GOMA
4	032.0003	OTTONE	BRASS	LAITON	MESSING	LATON
5	026.0061	ALLUMINIO	ALUMINIUM	ALUMINIUM	ALUMINIUM	ALUMINIO

Gummigripdon Serie GRU



PICK-UP HEAD

TETE DE PREHENSION

GREIFERKOPF

TULIPA

cod. 001.0105 ø 29

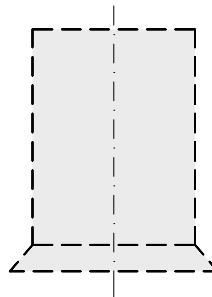
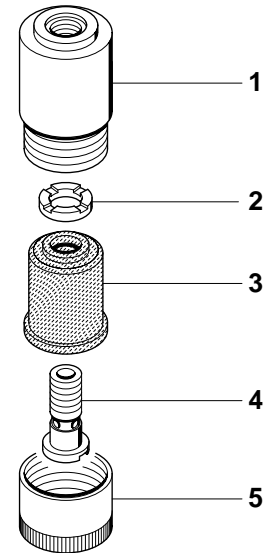
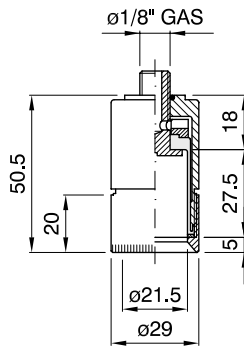

PROFILO INTERNO SCALA 1:1
 INTERNAL SECTION SCALE 1:1
 PROFIL INTERNE ECHELLE 1:1
 INNENPROFIL MASSTAB 1:1
 PERFIL INTERIOR ESCALA 1:1

	COD.	MATERIALE	MATERIAL	MATERIEL	WERKSTOFF	MATERIAL
1	027.0082	PA 66 + FV	PA 66 + FV	PA 66 + FV	PA 66 + FV	PA 66 + FV
2	032.0201	PA 66 + FV	PA 66 + FV	PA 66 + FV	PA 66 + FV	PA 66 + FV
3	040.0153	GOMMA	RUBBER	CAOUTCHOUC	GUMMI	GOMA
4	032.0003	OTTONE	BRASS	LAITON	MESSING	LATON
5	026.0129	ALLUMINIO	ALUMINIUM	ALUMINIUM	ALUMINIUM	ALUMINIO